

MULTIPLE CD PLAYER

103CD/104CD/1050CD DP-R797/R3090/R4090 SERVICE MANUAL

KENWOOD

© 1997-01/B51-5269-00 (K/K) 3795

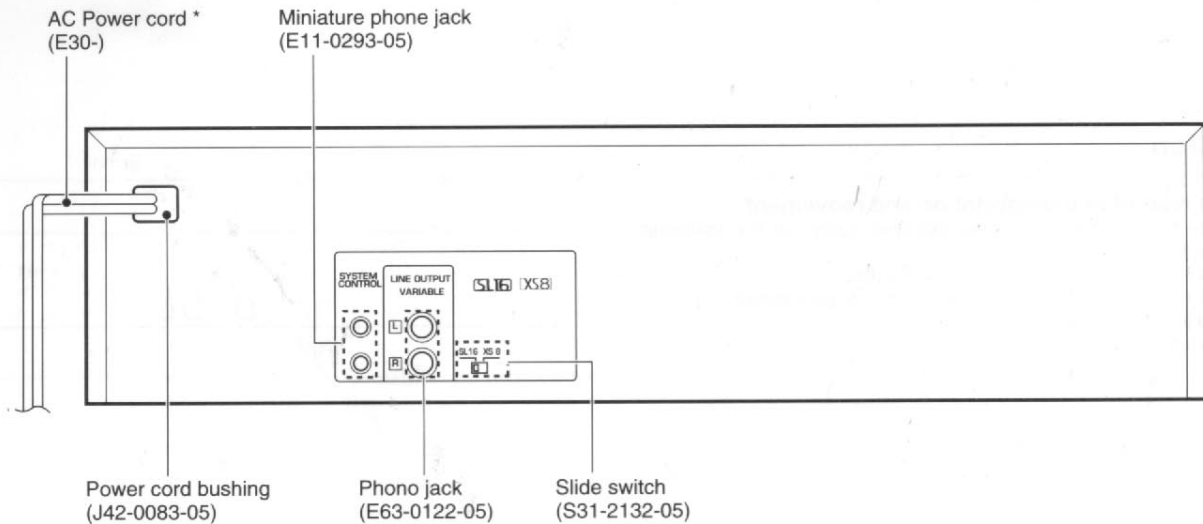
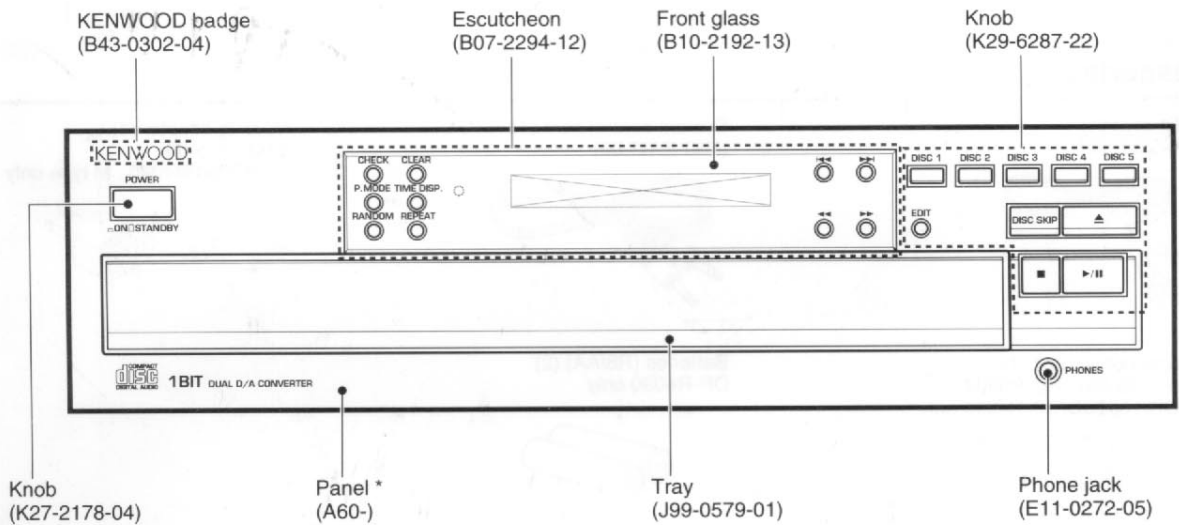

In compliance with Federal Regulations, following are reproductions of labels on, or inside the product relating to laser product safety.

KENWOOD-Corp. certifies this equipment conforms to DHHS Regulations No. 21 CFR 1040. 10, Chapter 1, Subchapter J.

**DANGER : Laser radiation when open and interlock defeated.
AVOID DIRECT EXPOSURE TO BEAM.**

Illust is DP-R4090.

* Refer to parts list on page 19.

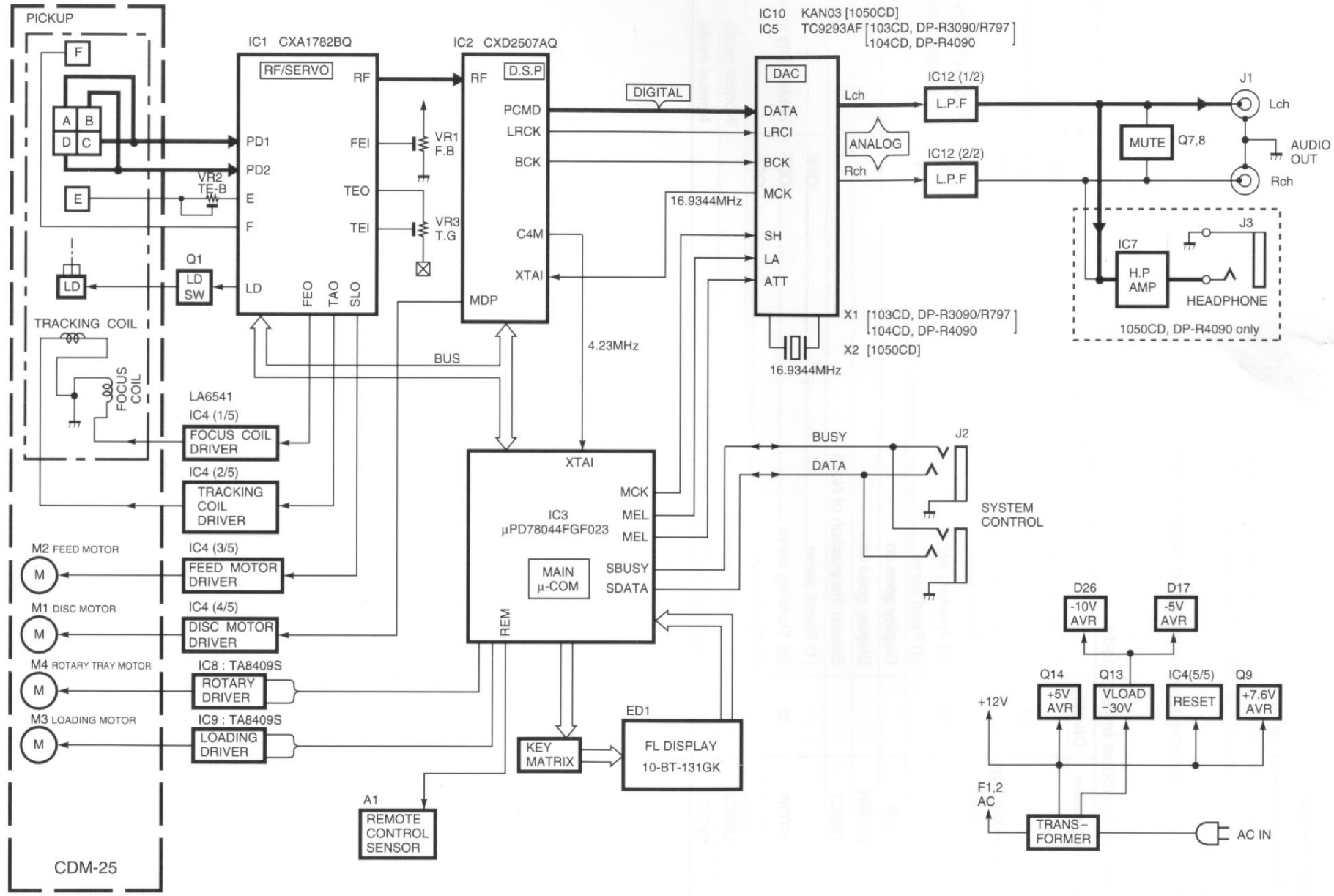

IC10 KAN03 [1050CD]
 IC5 TC9293AF [103CD, DP-R3090/R797]
 [104CD, DP-R4090]

103CD/104CD/1050CD/DP-R797/R3090/R4090
BLOCK DIAGRAM

103CD/104CD/1050CD/DP-R797/R3090/R4090

ADJUSTMENT

No.	ITEM	INPUT SETTINGS	OUTPUT SETTINGS	PLAYER SETTINGS	ALIGNMENT POINTS	ALIGN FOR	FIG.
Open the tray (Normal mode), then turn the power off.							
1	LASER POWER	—	Apply the sensor section of optical power meter on the pickup lens.	While pressing the TIME DISP. key, turn the AC ON. (Test mode) Press the PLAY/PAUSE key, then confirm that the display is "03".	—	On the power from 0.08 to 0.15 mW, when the diffraction grating is correctly aligned with the RF level of 1.0 Vp-p or more.	(a)
1. Press the STOP key. 2. Press the OPEN key. 3. Load a disc, then press the CLOSE key. 4. Press the PLAY key. 5. Press the OPEN key to open the tray. 6. Turn the power off. (Player stops as the tray is opened while the disc clamped.) 7. While pressing the TIME DISP. key, turn the power ON to enter the Test mode.							
2	TRACKING ERROR BALANCE	Test disc Type 4	Connect an oscilloscope as follows. CH1 : RF (CN2 pin 1) CH2 : TE1 (CN2 pin 6)	Press the PLAY/PAUSE key, then confirm that the display is "03".	TE BALANCE VR2	Symmetry between upper and lower patterns	(c)
3	FOCUS ERROR BALANCE	Test disc Type 4	Connect an oscilloscope as follows. CH1 : RF (CN2 pin 1) CH2 : TE1 (CN2 pin 6)	Press the PLAY/PAUSE key, then confirm that the display is "05".	FE BALANCE VR1	Optimum eye pattern	(b) or (d)
4	TRACKING GAIN	Test disc Type 4 Apply signal of 1.2 kHz, 50mVrms to CN2 pin 5-6.	Connect a LPF to CN2 pin 5-6 to which you connect an oscilloscope or AC voltmeters.	Press the PLAY/PAUSE key, then confirm that the display is "05".	TRACKING GAIN VR3	Two VTVMs should read the same value.	(e)

Note:

Type 4 disc : SONY YEDS-18 Test Disc or equivalent.

LPF: Around 47 kΩ+ 390 pF or so.

Step 1-4 are in Test Mode.

(a) Laser power

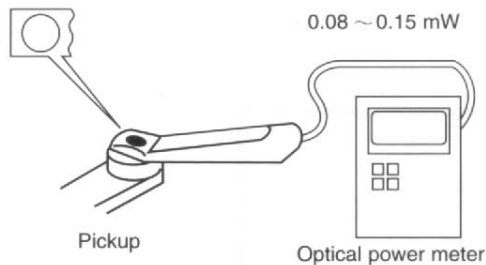

(e) Tracking gain

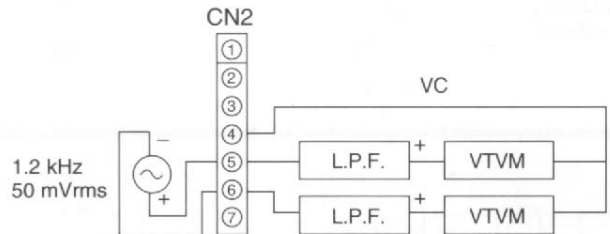

ADJUSTMENT

FIG. (b)

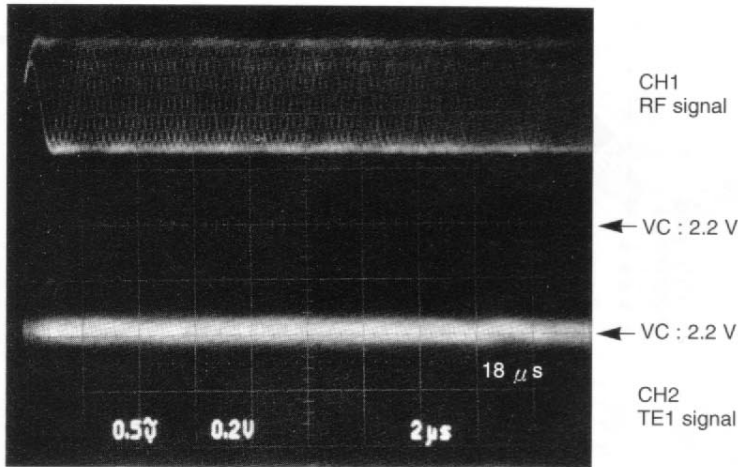

- RF signal and TE signal in test mode (PLAY).
- If the diffraction grating has been adjusted correctly, the influence of triggering is observed on the TE waveform of approx. $18 \mu s$ from RF signal trigger point, in the form of a projection.

FIG. (c)

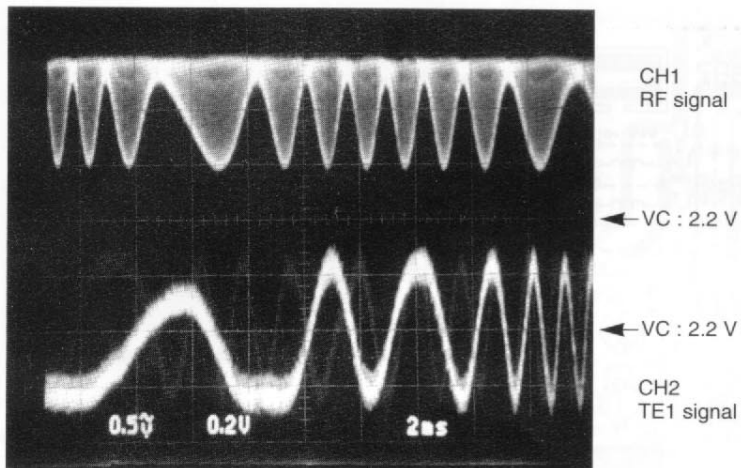

- RF signal and TE signal in test mode (Focusing servo ON / Tracking servo OFF). (Disc Type 4)
- Adjust TE signal so that the waveform is symmetrical in relation to VC. (TE BALANCE)

FIG. (d)

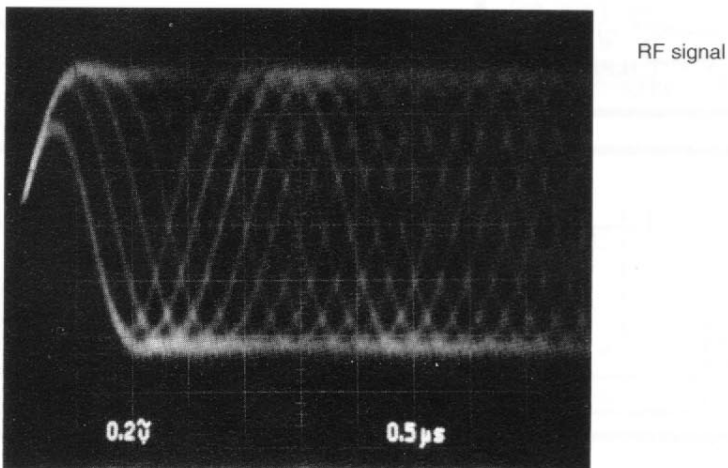

- RF signal in test mode (PLAY).
- Perform the tangential and focusing offset are focused into one point on the display. The crossing points above and below the center shall also be looked clearly. (FE BALANCE)

PC BOARD(Component side view)

CD player unit X32-328X-XX

- 0-10 : 1050CD (K, P) 0-
- 0-11 : 104CD (K, P) 0-
- 0-12 : 103CD (K, P) 0-
- DP-R797 (K, P)

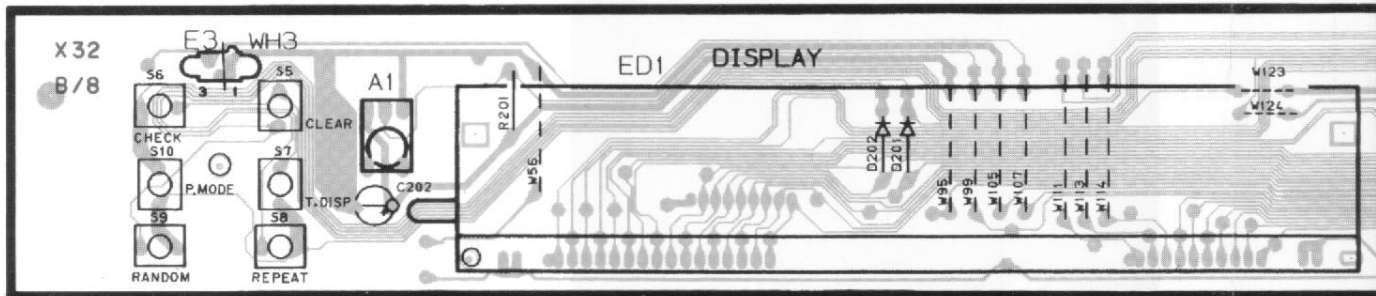
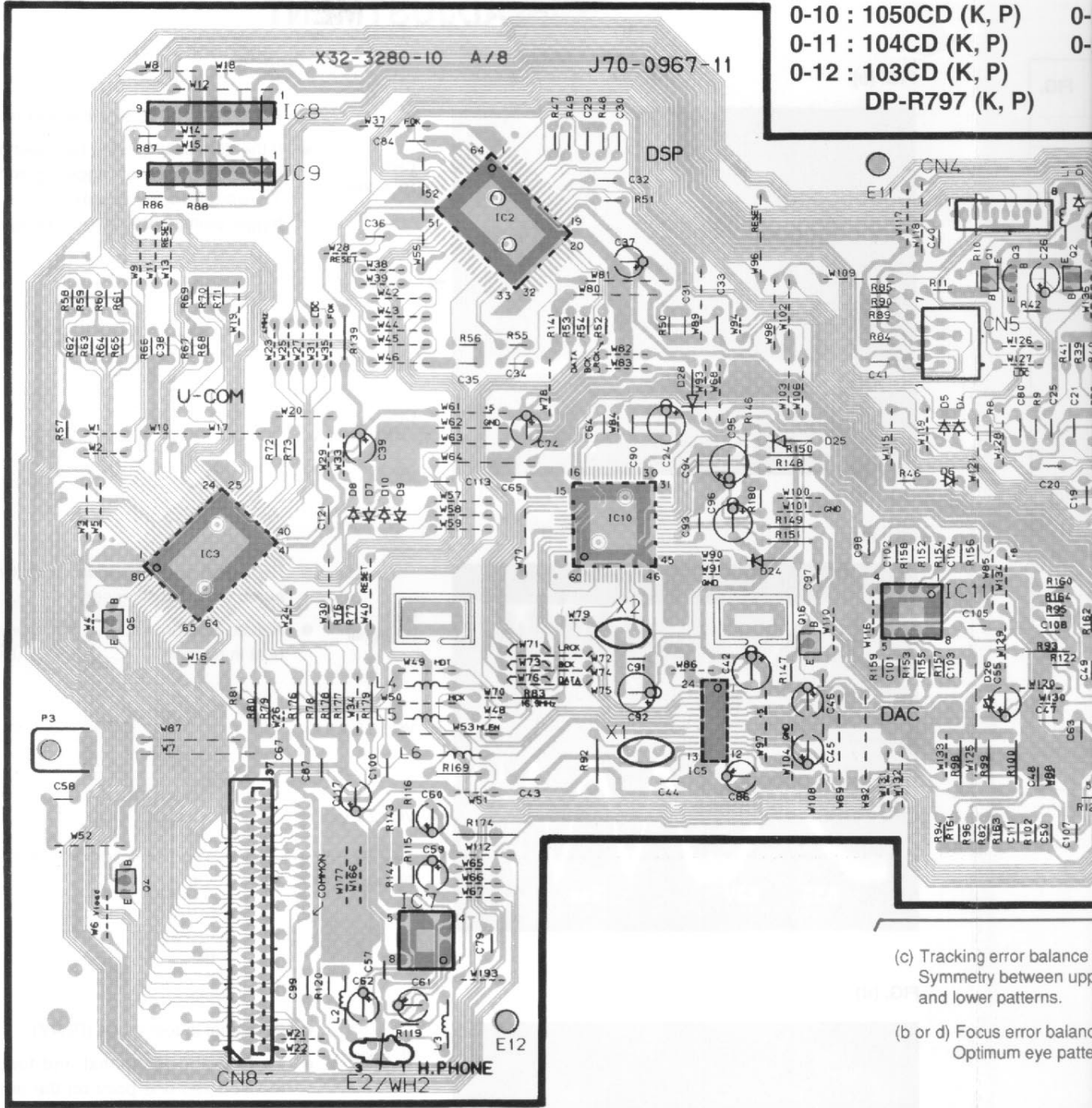

(c) Tracking error balance
Symmetry between upper
and lower patterns.

(b or d) Focus error balance
Optimum eye pattern

50CD (K, P)
 4CD (K, P)
 3CD (K, P)
 P-R797 (K, P)

0-21 : 1050CD (Y)
 0-22 : DP-R4090 (M)
 104CD (Y)

0-23 : DP-R3090 (M)
 103CD (Y)
 DP-R797 (Y)

2-71 : DP-R4090 (E, T, X)
 2-72 : DP-R3090 (E, T, X)

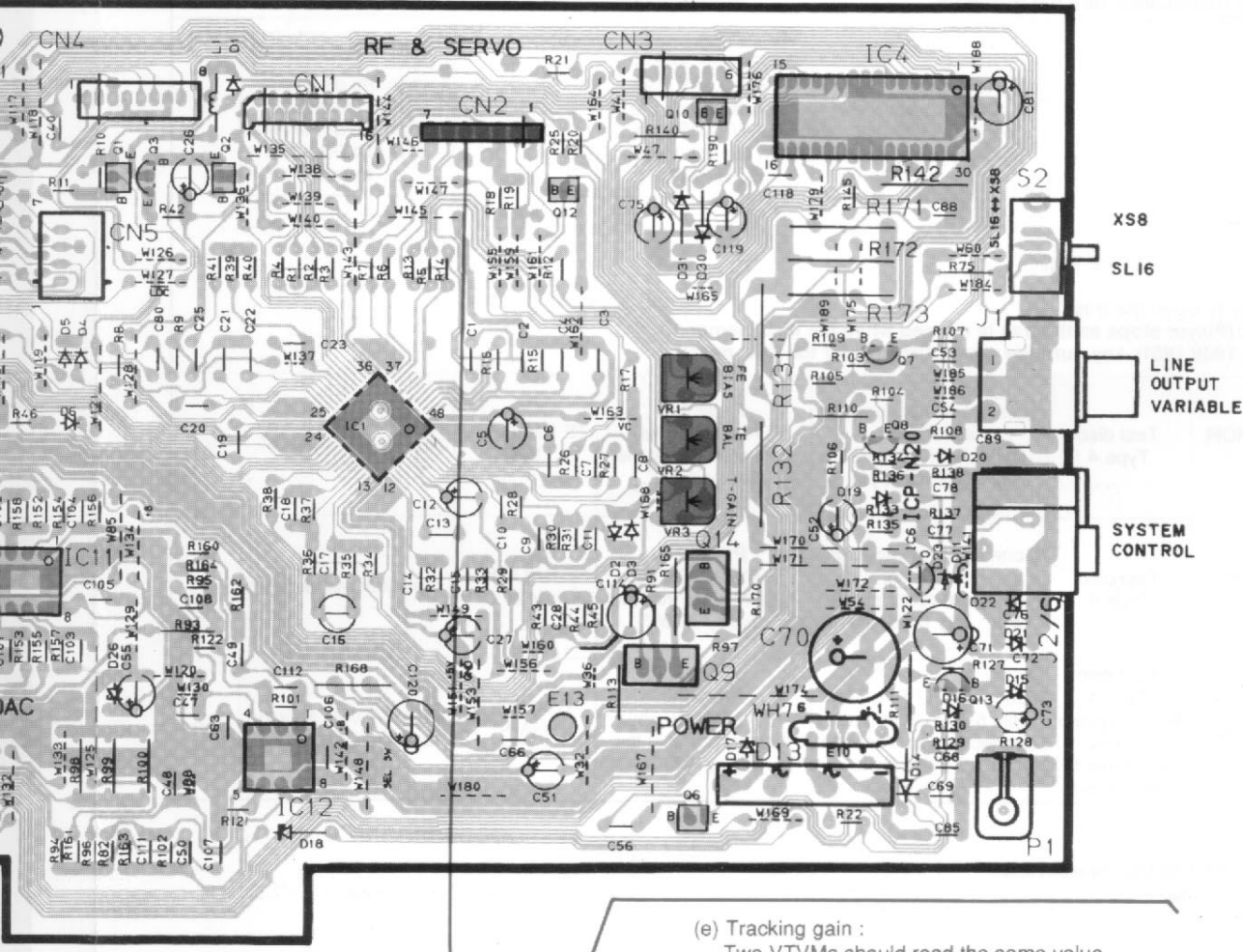

(c) Tracking error balance :
 Symmetry between upper
 and lower patterns.

(b) or (d) Focus error balance :
 Optimum eye pattern.

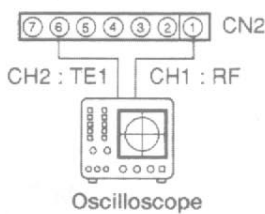

(e) Tracking gain :
 Two VTVMs should read the same value.

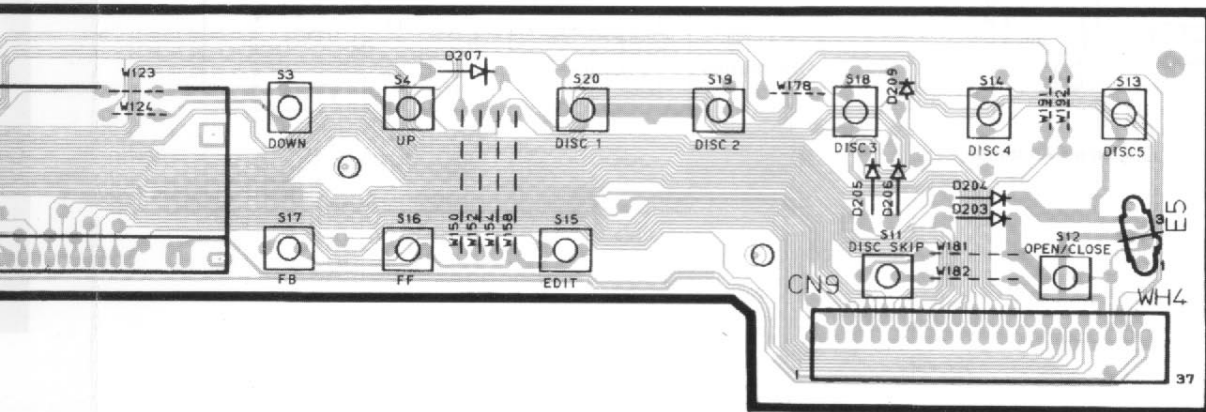
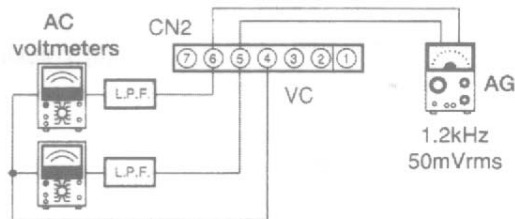

PC BOARD(Component side view)

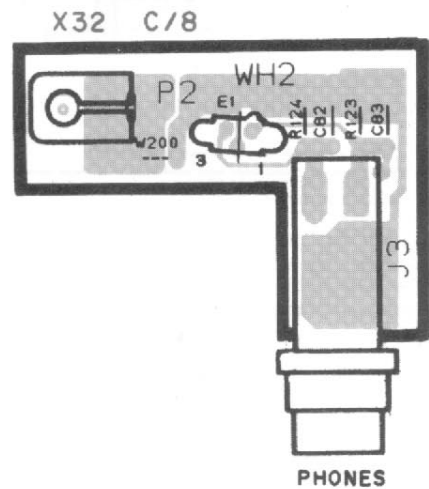
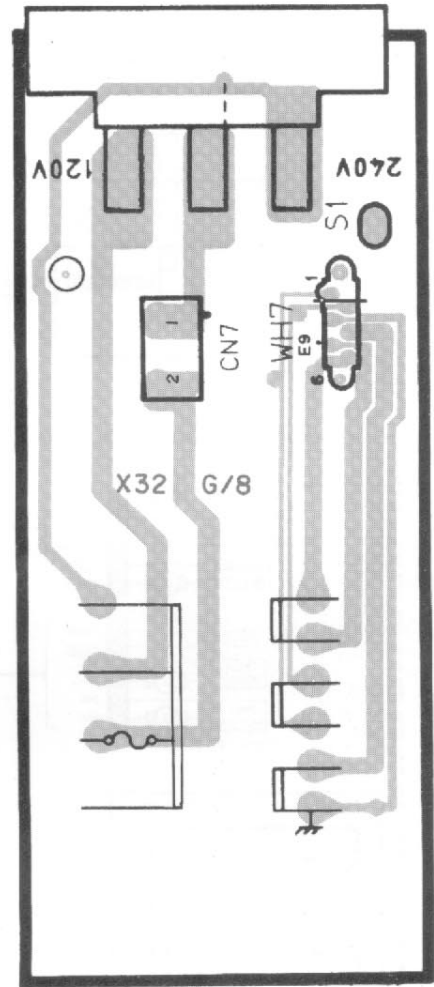
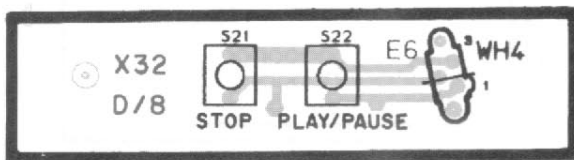
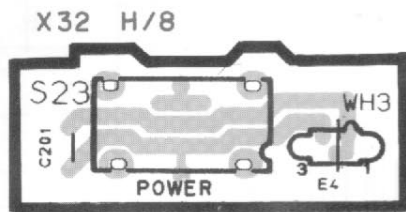
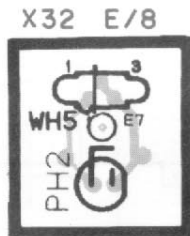
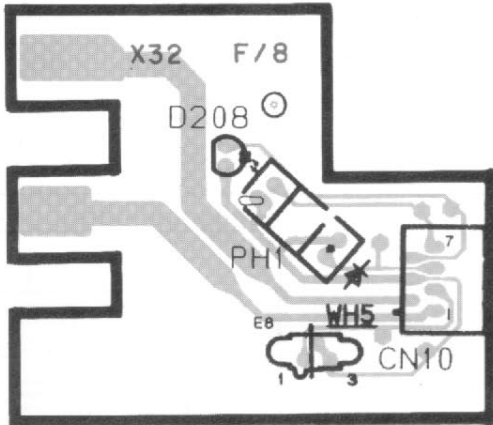

Refer to the schematic diagram for the value of resistors and capacitors.

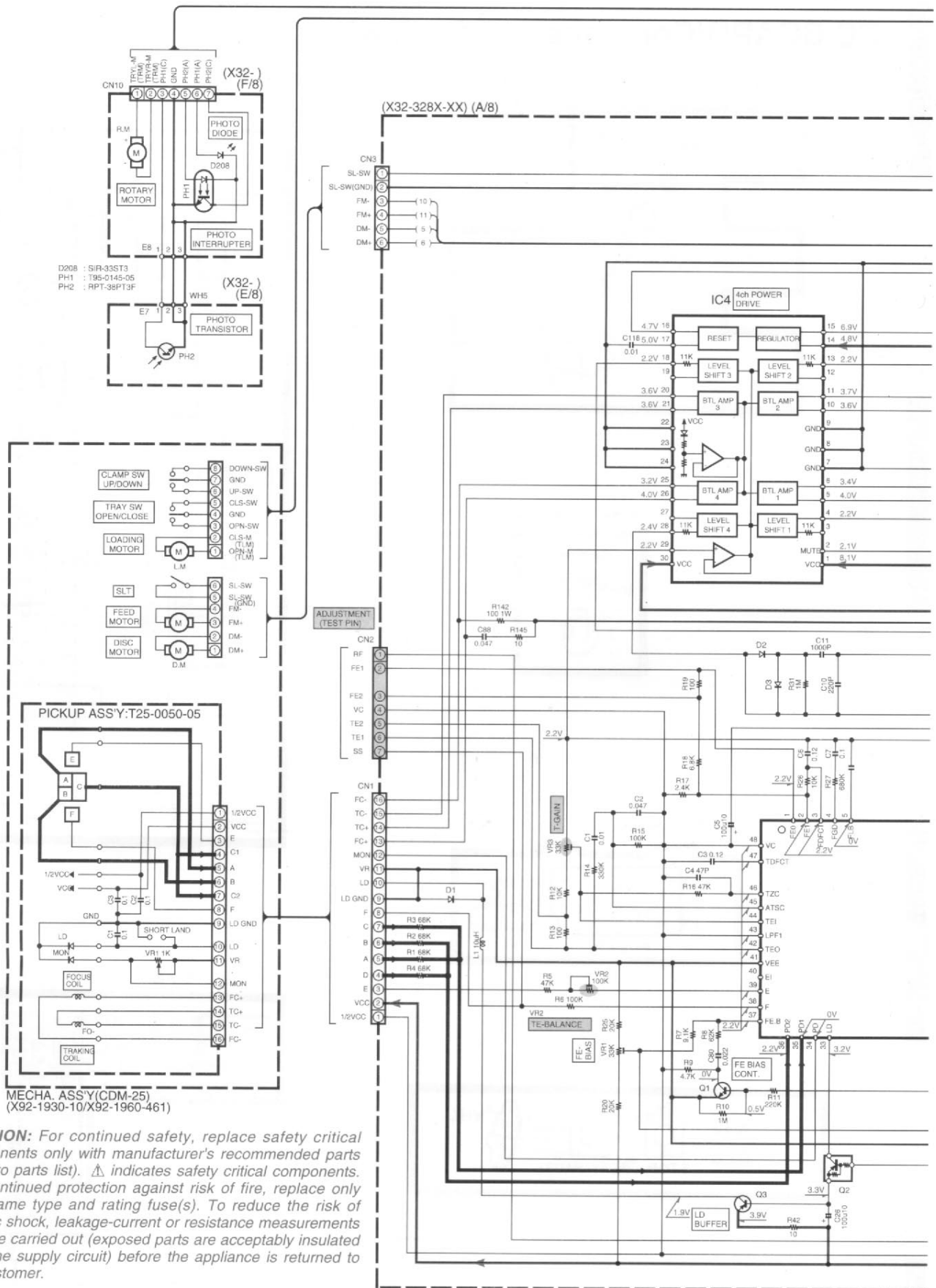

D208 : S1R-335T3
 PH1 : T95-0145-05
 PH2 : RPT-38PT3F

MECHA. ASS'Y(CDM-25)
 (X92-1930-10/X92-1960-461)

CAUTION: For continued safety, replace safety critical components only with manufacturer's recommended parts (refer to parts list). Δ indicates safety critical components. For continued protection against risk of fire, replace only with same type and rating fuse(s). To reduce the risk of electric shock, leakage-current or resistance measurements shall be carried out (exposed parts are acceptably insulated from the supply circuit) before the appliance is returned to the customer.

The DC voltage is an actual reading measured with a high impedance type voltmeter. The measurement value may vary depending on the measuring instruments used or on the product. Refer to the voltage during PLAY unless otherwise specified; The value shown in () is the voltage measured at the moment of STOP.

KAN03

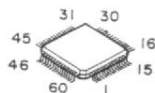

CXD2507AQ*1

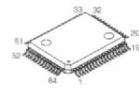

LA6541D



F

G

H

I

J

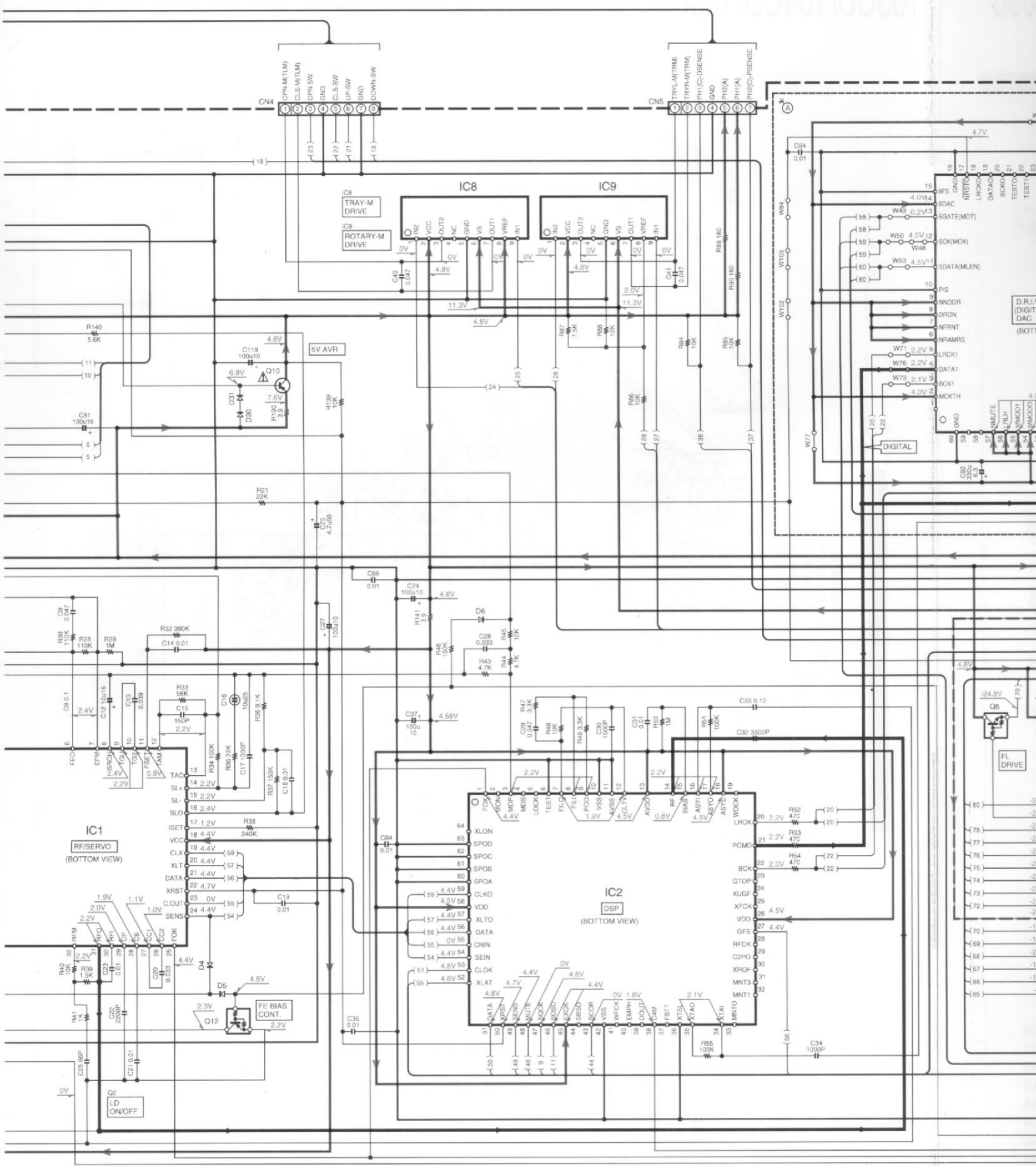

2SA1534A
2SA954
2SA992
2SC2878

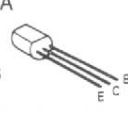

2SC2785

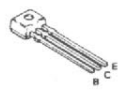

DTA124ESA
DTC124ESA
UN4112
2SC1740S

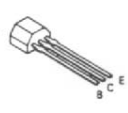

UN4212
UN4219

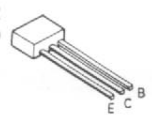

2SD2012



NJM4565D

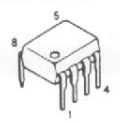

TA84



1050CD
X32-328X-XX

DESTINATION	COUNTRY	ABB	UNIT No.	A	B	C	IC3	IC6	D11	D23	S1	C99	R91, 97	E12	W122	W141	W197
U.S.A.	K	P	0-10	YES	NO	YES	uPD78044F-GF043	NO	NO	UZ-3.9BSB or MTJ3.9(B)	NO	NO	180	YES	YES	NO	YES
CANADA	K	P	0-10	YES	NO	YES	uPD78044F-GF043	NO	NO	UZ-3.9BSB or MTJ3.9(B)	NO	NO	180	YES	YES	NO	YES
PX	Y	X	0-21	YES	NO	YES	uPD78044F-GF043	NO	NO	UZ-3.9BSB or MTJ3.9(B)	NO	NO	180	YES	YES	NO	YES

1040CD
X32-328X-XX

DESTINATION	COUNTRY	ABB	UNIT No.	A	B	C	IC3	IC6	D11	
U.S.A.	K	P	0-11	YES	NO	YES	uPD78044F-GF023 or uPD78044F-GF043	NO	NO	UZ-3.9BSB or MTJ3.9(B)
CANADA	K	P	0-11	YES	NO	YES	uPD78044F-GF023 or uPD78044F-GF043	NO	NO	UZ-3.9BSB or MTJ3.9(B)
PX	Y	X	0-22	YES	NO	YES	uPD78044F-GF023 or uPD78044F-GF043	NO	NO	UZ-3.9BSB or MTJ3.9(B)
GENERAL MARKET	X	M	0-22	YES	NO	YES	uPD78044F-GF023 or uPD78044F-GF043	NO	NO	UZ-3.9BSB or MTJ3.9(B)
AUSTRALIA	X	T	0-21	YES	NO	YES	uPD78044F-GF023 or uPD78044F-GF043	NO	NO	UZ-3.9BSB or MTJ3.9(B)
U.K.	X	T	0-21	YES	NO	YES	uPD78044F-GF023 or uPD78044F-GF043	NO	NO	UZ-3.9BSB or MTJ3.9(B)
EUROPE	X	T	0-21	YES	NO	YES	uPD78044F-GF023 or uPD78044F-GF043	NO	NO	UZ-3.9BSB or MTJ3.9(B)

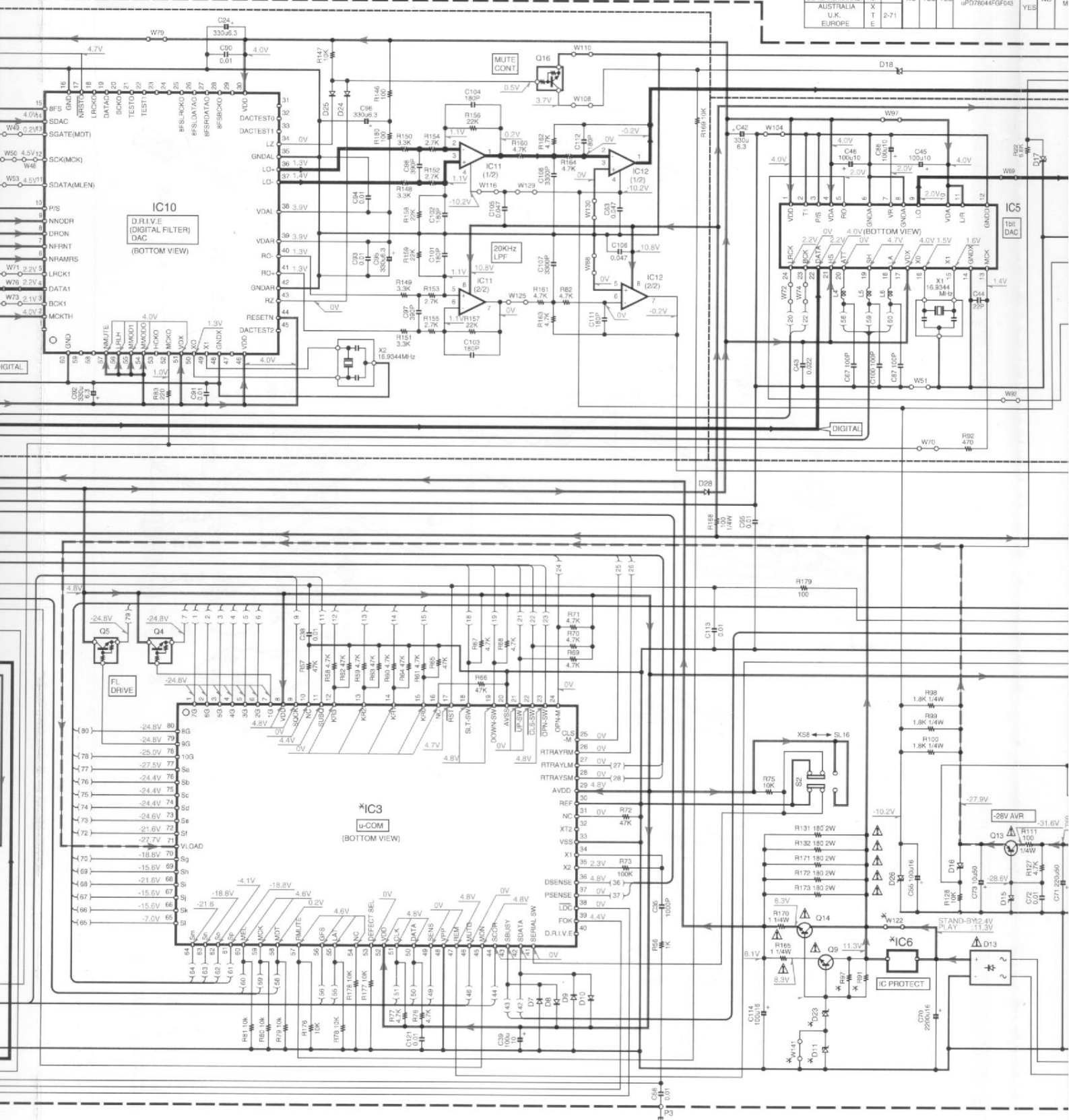

TA8409S

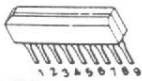

NJM4580D



TC9293AF

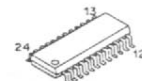

CXA1782BQ*1

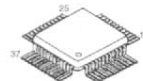

ICP-N20

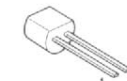

B	C	IC3	IC5	D11	D23	S1	C99	R91, 97	E12	W122	W141	W187
NO	NO	NO	NO	NO	NO	NO	NO	NO	NO	NO	NO	NO
YES	YES	UPD78044FGF023 or UPD78044FGF043	YES	NO	UZ-8.2BSB or MTZJ.8.2(B)	YES	YES	470	YES	NO	YES	NO
				YES		NO				NO		YES

103CD X32-328X-XX																	
DESTINATION	COUNTRY	ABB	UNIT No.	A	B	C	IC3	IC5	D11	D23	S1	C99	R91, 97	E12	W122	W141	W187
U.S.A.	U.S.A.	K	P	0-12					NO		NO	NO					YES
CANADA	CANADA	K	P	0-12					NO		NO	NO					YES
PX		Y		0-23					NO		NO	YES	470	NO		YES	NO
GENERAL MARKET		M			NO	YES	NO	UPD78044FGF023 or UPD78044FGF043	YES	NO	UZ-8.2BSB or MTZJ.8.2(B)	YES	470	NO	NO	YES	NO
AUSTRALIA	AUSTRALIA	X	T	2-72					YES		NO	NO					YES
U.K.	U.K.	X	T	2-72					YES		NO	NO					YES
EUROPE	EUROPE	T	E						NO		NO	NO					YES

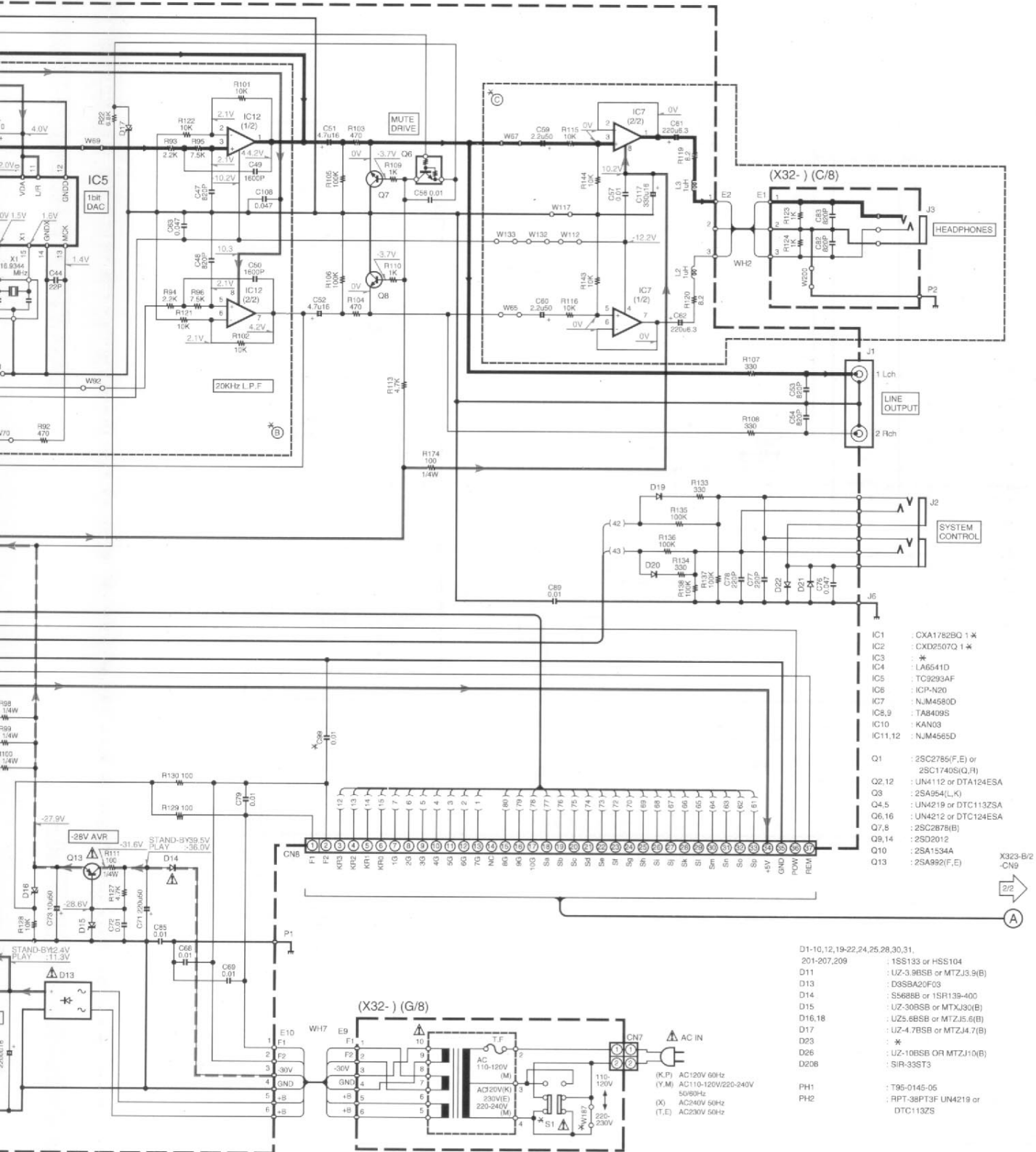

- IC1 : CXA1782B0 1 *
 - IC2 : CXD2507Q 1 *
 - IC3 : *
 - IC4 : LA6541D
 - IC5 : TC9293AF
 - IC6 : ICP-N20
 - IC7 : NJM4580D
 - IC8 : TA8409S
 - IC10 : KAN03
 - IC11,12 : NJM4565D
- Q1 : 2SC2785(F,E) or 2SC1740S(Q,F)
 - Q2,12 : UN4112 or DTA124ESA
 - Q3 : 2SA954(L,K)
 - Q4,5 : UN4219 or DTC113ZSA
 - O6,16 : UN4212 or DTC124ESA
 - Q7,8 : 2SC2878(B)
 - Q9,14 : 2SD2012
 - Q10 : 2SA1534A
 - Q13 : 2SA992(F,E)

- D1-10,12,19-22,24,25,28,30,31, 201-207,209 : 1S5133 or HSS104
 - D11 : UZ-3.9BSB or MTZJ3.9(B)
 - D13 : D3SBA20F03
 - D14 : S5688B or 1SR139-400
 - D15 : UZ-30BSB or MTZJ30(B)
 - D16,18 : UZ5.8BSB or MTZJ5.8(B)
 - D17 : UZ-4.7BSB or MTZJ4.7(B)
 - D23 : *
 - D26 : UZ-10BSB OR MTZJ10(B)
 - D208 : SIR-33S73
- PH1 : T95-0145-05
 - PH2 : RPT-38PT3F UN4219 or DTC113ZS

1050CD/104CD/103CD(K) (1/2)

103CD/104CD/1050CD/DP-R797/R3090/R4090

Y22-4870-10

KENWOOD

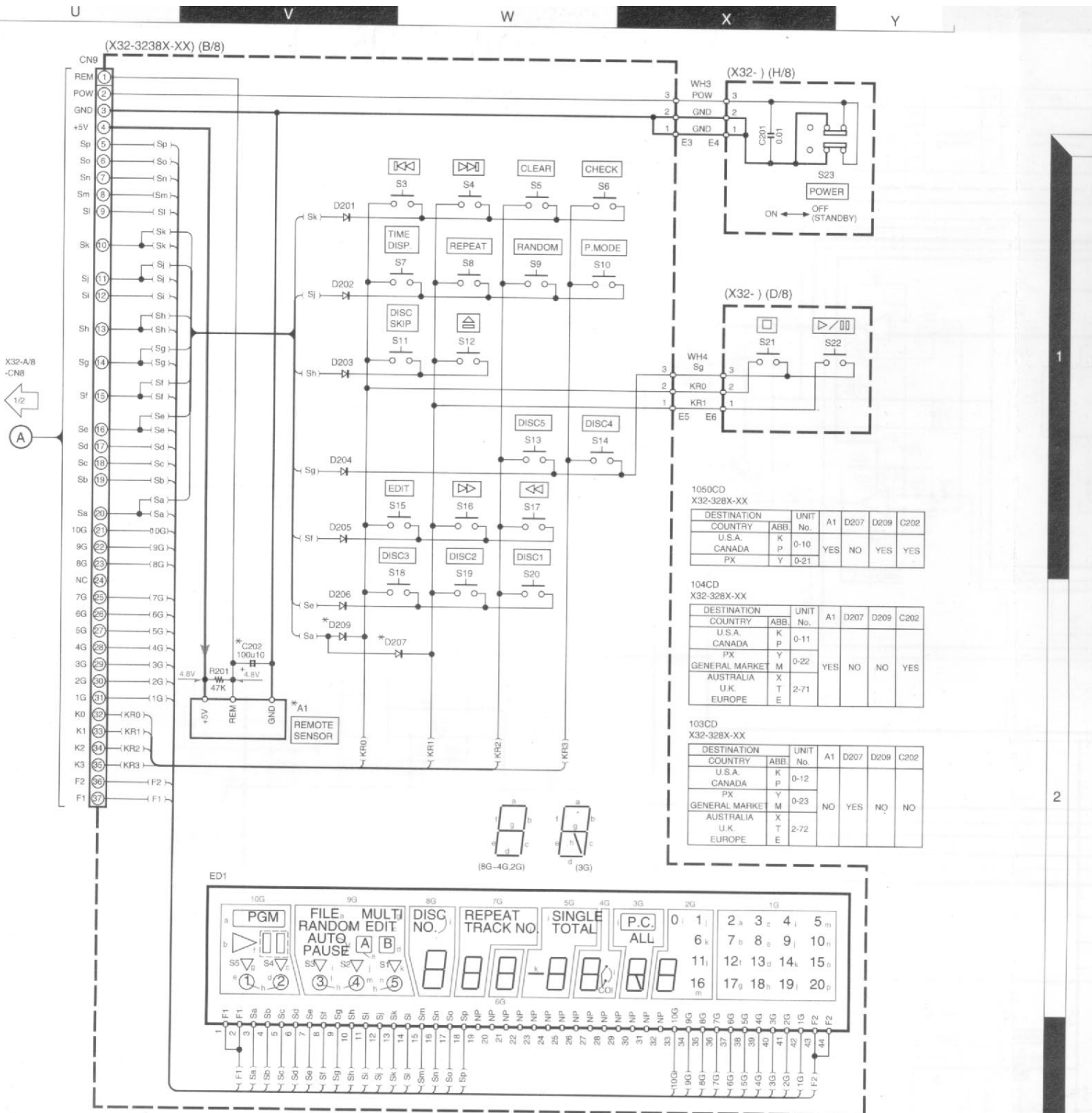

1050CD
X32-328X-XX

DESTINATION	COUNTRY	ABB.	UNIT No.	A1	D207	D209	C202
U.S.A.	K	P	0-10	YES	NO	YES	YES
CANADA	K	P	0-10	YES	NO	YES	YES
PX	Y		0-21	YES	NO	YES	YES

104CD
X32-328X-XX

DESTINATION	COUNTRY	ABB.	UNIT No.	A1	D207	D209	C202
U.S.A.	K	P	0-11				
CANADA	K	P	0-11				
PX	Y		0-22	YES	NO	NO	YES
GENERAL MARKET	M						
AUSTRALIA	X						
U.K.	T		2-71				
EUROPE	E						

103CD
X32-328X-XX

DESTINATION	COUNTRY	ABB.	UNIT No.	A1	D207	D209	C202
U.S.A.	K	P	0-12				
CANADA	K	P	0-12				
PX	Y		0-23	NO	YES	NO	NO
GENERAL MARKET	M						
AUSTRALIA	X						
U.K.	T		2-72				
EUROPE	E						

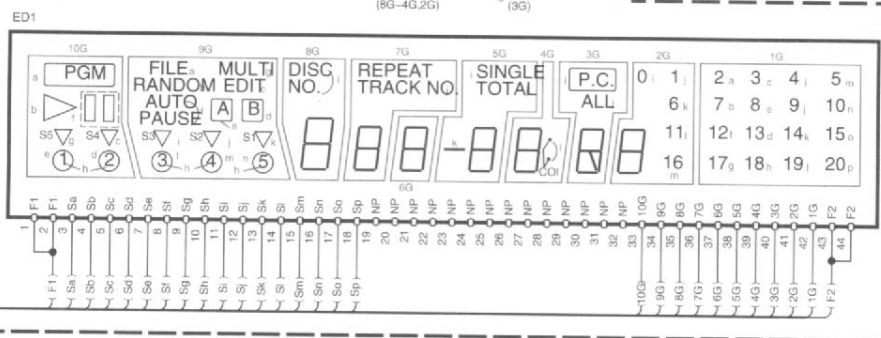
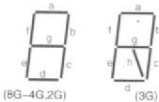

ED1 : 10-BT-131GK
 A1 : W02-2537-05
 GND LINE
 +B LINE
 1050CD/104CD/103CD(K) (2/2)

CAUTION: For continued safety, replace safety critical components only with manufacturer's recommended parts (refer to parts list). Δ indicates safety critical components. For continued protection against risk of fire, replace only with same type and rating fuse(s). To reduce the risk of electric shock, leakage-current or resistance measurements shall be carried out (exposed parts are acceptably insulated from the supply circuit) before the appliance is returned to the customer.

The DC voltage is an actual reading measured with a high impedance type voltmeter. The measurement value may vary depending on the measuring instruments used or on the product. Refer to the voltage during PLAY unless otherwise specified; The value shown in () is the voltage measured at the moment of STOP.

103CD/104CD/1050CD/DP-R797/R3090/R4090

Y22-4870-10

KENWOOD

EXPLODED VIEW (UNIT)

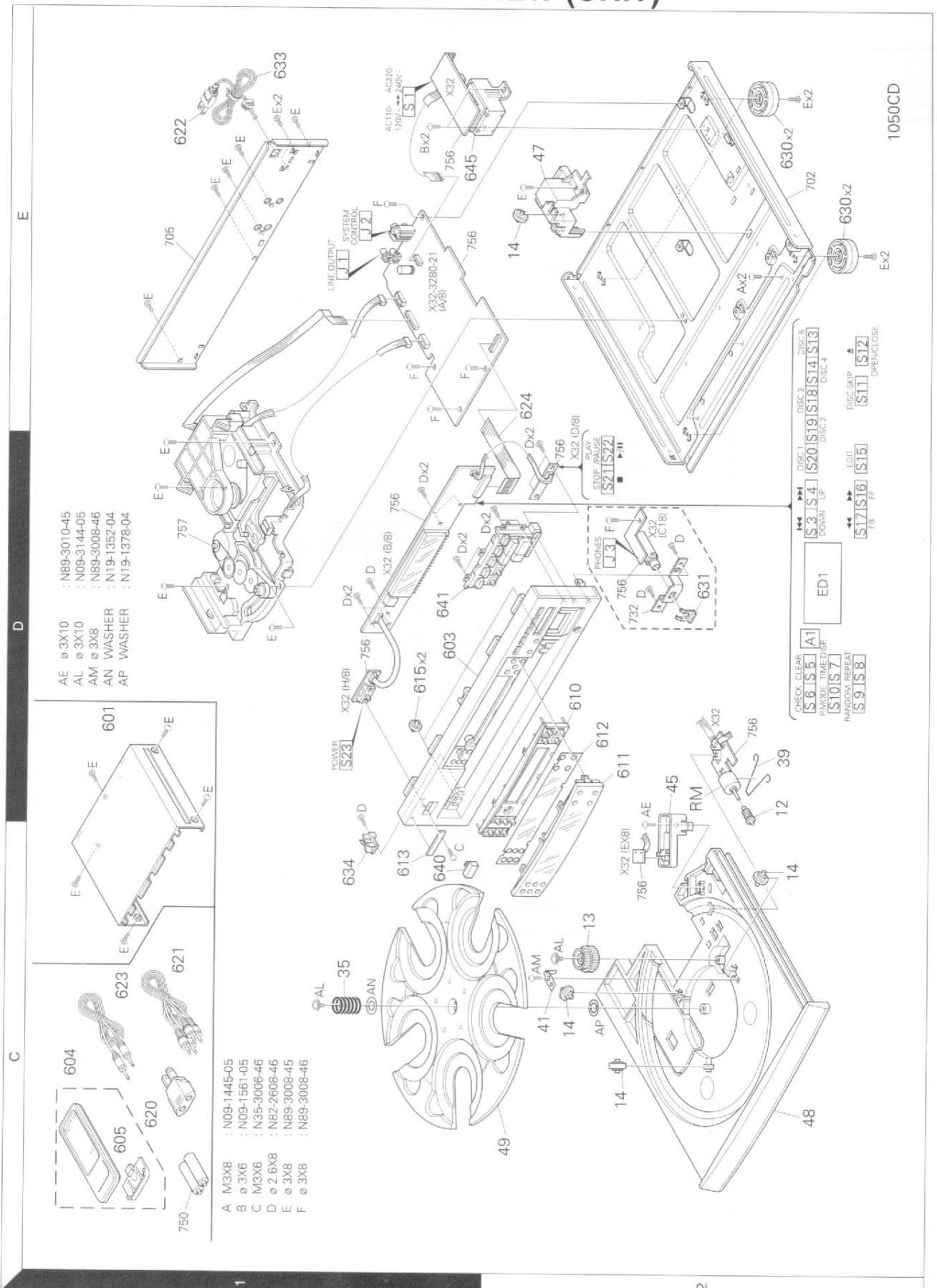

- AE ϕ 3X10 : N89-3010-45
- AL ϕ 3X10 : N09-3144-05
- AM ϕ 3X8 : N89-3008-46
- AN WASHER : N19-1352-04
- AP WASHER : N19-1378-04

- A M3X8 : N09-1445-05
- B ϕ 3X6 : N09-1561-05
- C M3X6 : N35-3006-46
- D ϕ 2.6X8 : N82-2608-46
- E ϕ 3X8 : N89-3008-45
- F ϕ 3X8 : N89-3008-46

ED1

CHECK CLEAR [S6] [S5] [A1]

PAUSE TIME DISP [S10] [S7]

MANUAL REPEAT [S9] [S8]

DOWN UP [S3] [S4] [S20] [S19] [S18] [S14] [S13]

DISC 3 [S18] [S18] [S18] [S18] [S18] [S18]

DISC 4 [S18] [S18] [S18] [S18] [S18] [S18]

DISC SKIP [S11] [S12]

OPEN/CLOSE [S11] [S12]

LEFT [S17] [S16] [S15]

RIGHT [S17] [S16] [S15]

STOP PAUSE [S21] [S22]

X32 (D/B) [S21] [S22]

X32 (I/B) [S21] [S22]

PHONES [J3] [F]

732 D [S21] [S22]

732 C [S21] [S22]

732 B [S21] [S22]

732 A [S21] [S22]

732 [S21] [S22]

1050CD

EXPLODED VIEW (MECHANISM)

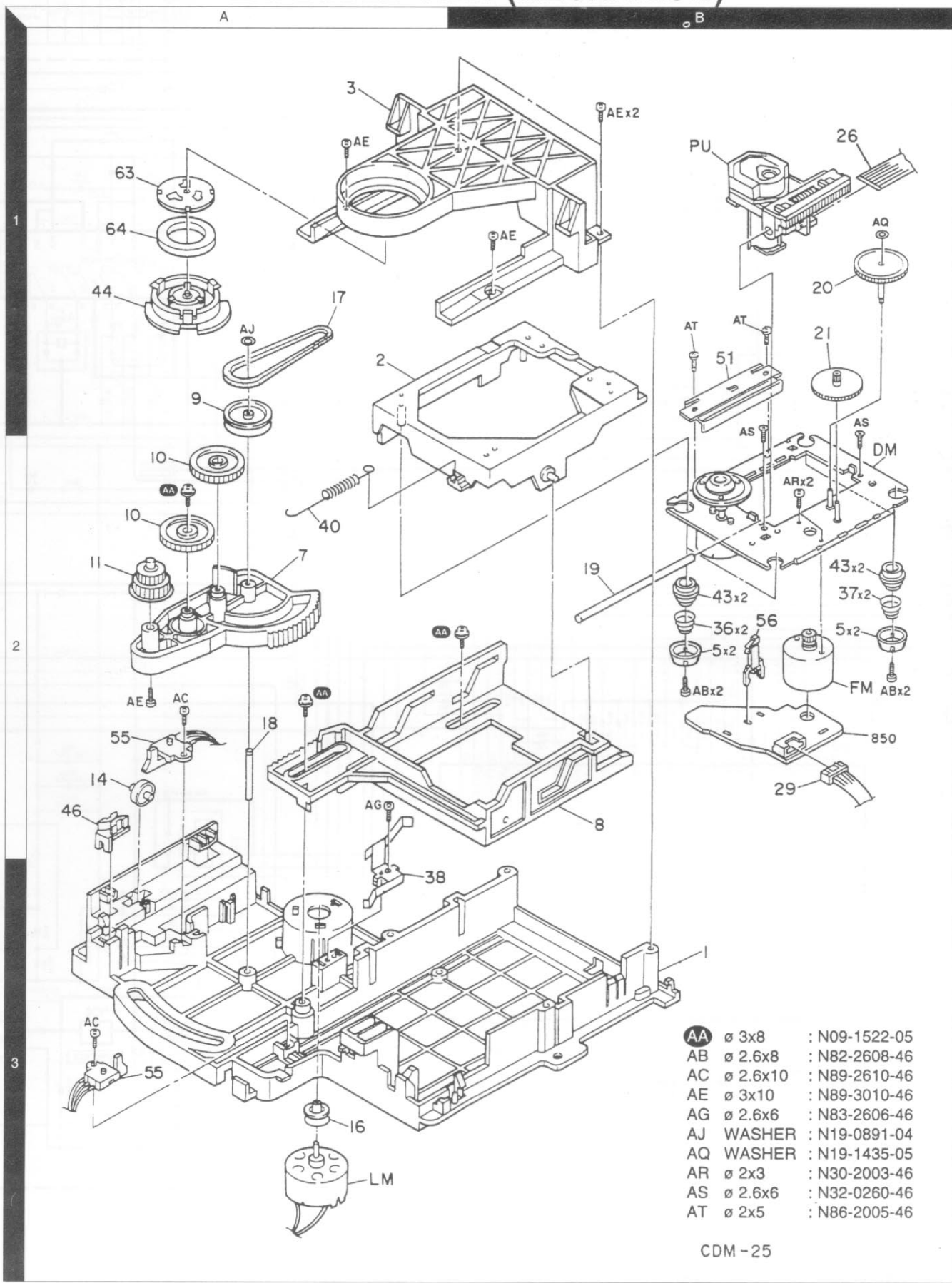

- AA \varnothing 3x8 : N09-1522-05
- AB \varnothing 2.6x8 : N82-2608-46
- AC \varnothing 2.6x10 : N89-2610-46
- AE \varnothing 3x10 : N89-3010-46
- AG \varnothing 2.6x6 : N83-2606-46
- AJ WASHER : N19-0891-04
- AQ WASHER : N19-1435-05
- AR \varnothing 2x3 : N30-2003-46
- AS \varnothing 2.6x6 : N32-0260-46
- AT \varnothing 2x5 : N86-2005-46

CDM - 25

103CD/104CD/1050CD/DP-R797/R3090/R4090

SPECIFICATIONS

[Format]

System Compact disc digital audio system
Laser Semiconductor laser

[D/A Convertors]

D/A Conversion 1Bit
Oversampling 8 fs (352.8 kHz)

[Audio]

Frequency response 4 Hz ~ 20 kHz, ± 0.5 dB
Signal to noise ratio More than 95 dB
Dynamic range More than 95 dB
Total harmonic distortion +noise
..... Less than 0.008 % (at 1 kHz)
Wow & flutter Unmeasurable Limit
Output level / impedance
Fixed (DP-R3090) 2.0 V / 0.8 k Ω
Variable (DP-R4090) (max.) 2.0 V / 0.8 k Ω
Headphone output (max.)
(DP-R4090 only) 20 mW (32 Ω)

[General]

Power consumption 13 W
Dimensions W : 440 mm (17-5/16")
H : 125 mm (4-15/16")
D : 397 mm (15-5/8")
Weight (Net) 5.0 kg (11.0 lb)

Note :

We follow a policy of continuous advancements in development. For this reason specifications may be changed without notice.

Note:

Component and circuitry are subject to modification to insure best operation under differing local conditions. This manual is based on Europe (E) standard, and provides information on regional circuit modification through use of alternate schematic diagrams, and information on regional component variations through use of parts list.

KENWOOD CORPORATION

14-6, Dogenzaka 1-chome, Shibuya-ku, Tokyo, 150 Japan

KENWOOD SERVICE CORPORATION

P.O. BOX 22745, 2201 East Dominguez St., Long Beach, CA 90801-5745, U.S.A.

KENWOOD ELECTRONICS CANADA INC.

6070 Kestrel Road, Mississauga, Ontario, Canada L5T 1S8

KENWOOD ELECTRONICS LATIN AMERICA S.A.

P.O. BOX 55-2791, Piso 6 plaza Chase, Cl. 47 y Aquilino de la Guardia Panama, Republic de Panama

KENWOOD ELECTRONICS U.K. LIMITED

KENWOOD House, Dwight Road, Watford, Herts., WD1 8EB., United Kingdom

KENWOOD ELECTRONICS BENELUX N.V.

Meachelsesteenweg 418, B-1930 Zaventem, Belgium

KENWOOD ELECTRONICS DEUTSCHLAND GMBH

Rembrücker Str. 15, 63150 Heusenstamm, Germany

KENWOOD ELECTRONICS FRANCE S.A.

13 Boulevard Ney, 75018 Paris, France

KENWOOD ELECTRONICS ITALIA S.p.A.

Via G. Sirtori, 7/9 20129, Milano, Italy

KENWOOD IBÉRICA S.A.

Bolivia, 239-08020 Barcelona, Spain

KENWOOD ELECTRONICS AUSTRALIA PTY. LTD.

(A.C.N. 001499 074)

P.O. Box 504, 8 Figtree Drive, Australia Centre, Homebush, N.S.W. 2140, Australia

KENWOOD & LEE ELECTRONICS, LTD.

Unit 3712-3724, Level 37, Tower 1, Metroplaza, 223 Hing Fong Road, Kwai Fong N.T., Hong Kong

KENWOOD ELECTRONICS GULF FZE

P.O. Box 61318, Jebel Ali, Dubai, U.A.E.

KENWOOD ELECTRONICS SINGAPORE PTE LTD.

No. 1 Genting Lane #02-02, KENWOOD Building, Singapore, 349544

KENWOOD ELECTRONICS (MALAYSIA) SDN BHD.

#4.01 Level 4, Wisma Academy Lot 4A, Jalan 19/1 46300 Petaling Jaya Selangor Darul Ehsan Malaysia